

A 3D architectural rendering of a city development project. The scene shows a river flowing through a city, with various buildings, green spaces, and infrastructure. The buildings are rendered in white and grey, while the green spaces are in shades of green. The river is blue. The overall style is clean and modern.

ROERDELTA INFO AVOND

1. PLAN OPZET

2. RELATIE MET DE OMGEVING

3. BEELDKWALITEIT FASE 2 EN 3

PLAN OPZET

DE STAD AAN HET WATER

DE VERBINDINGEN STAD-MAAS

Zone - bestaande buurt

Zone 1

Aansluiting op stedelijk karakter van omgeving

Zone 2

Open bouwblokken in een groen oeverpark; integratie van bestaande kavels vormen samen één open blok

Zone 3

Landschappelijke benadering staat centraal; referentie naar historische situatie van industrie. Alzijdige gesloten bouwblokken in het groen

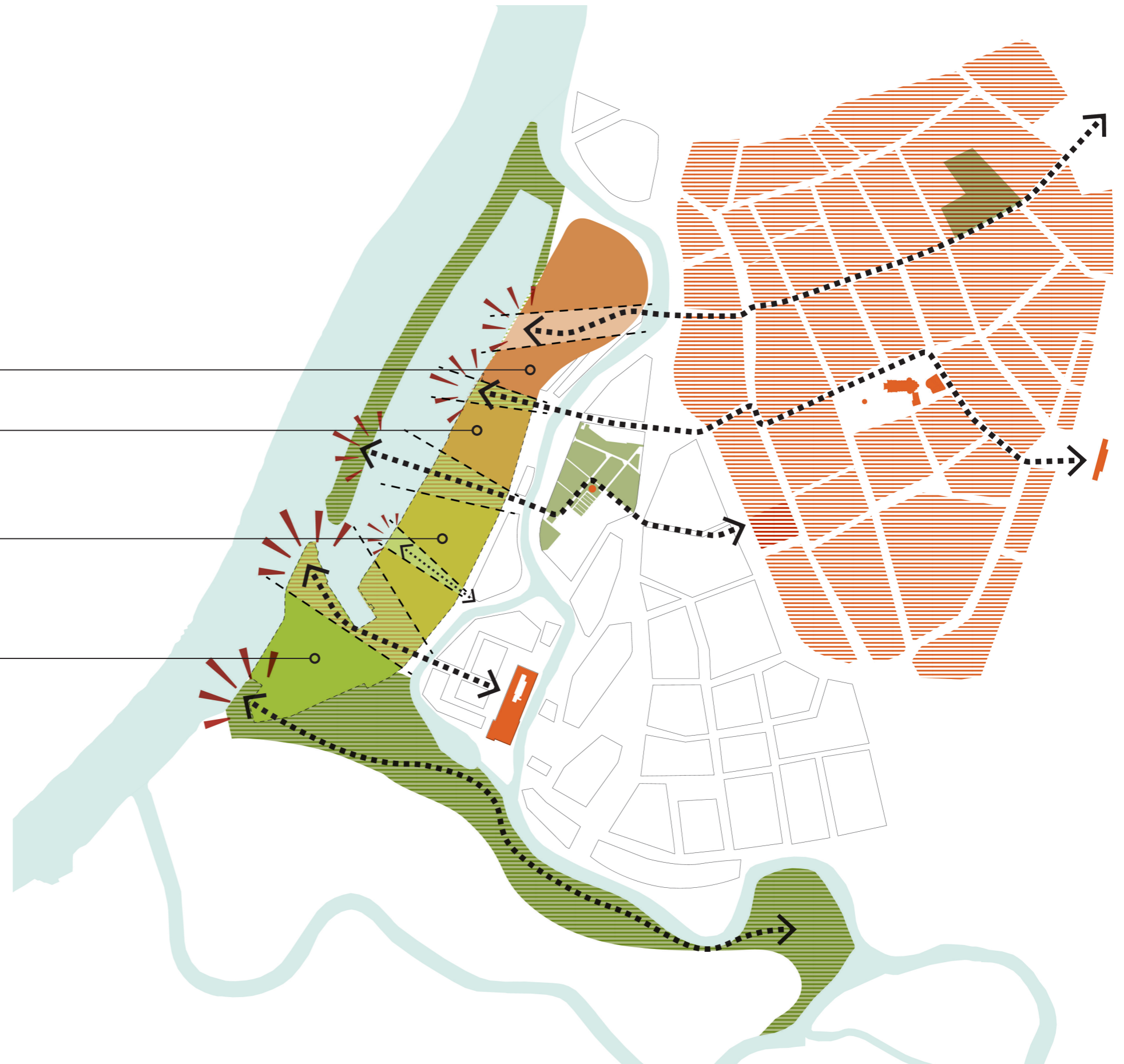



3 KARAKTERZONES

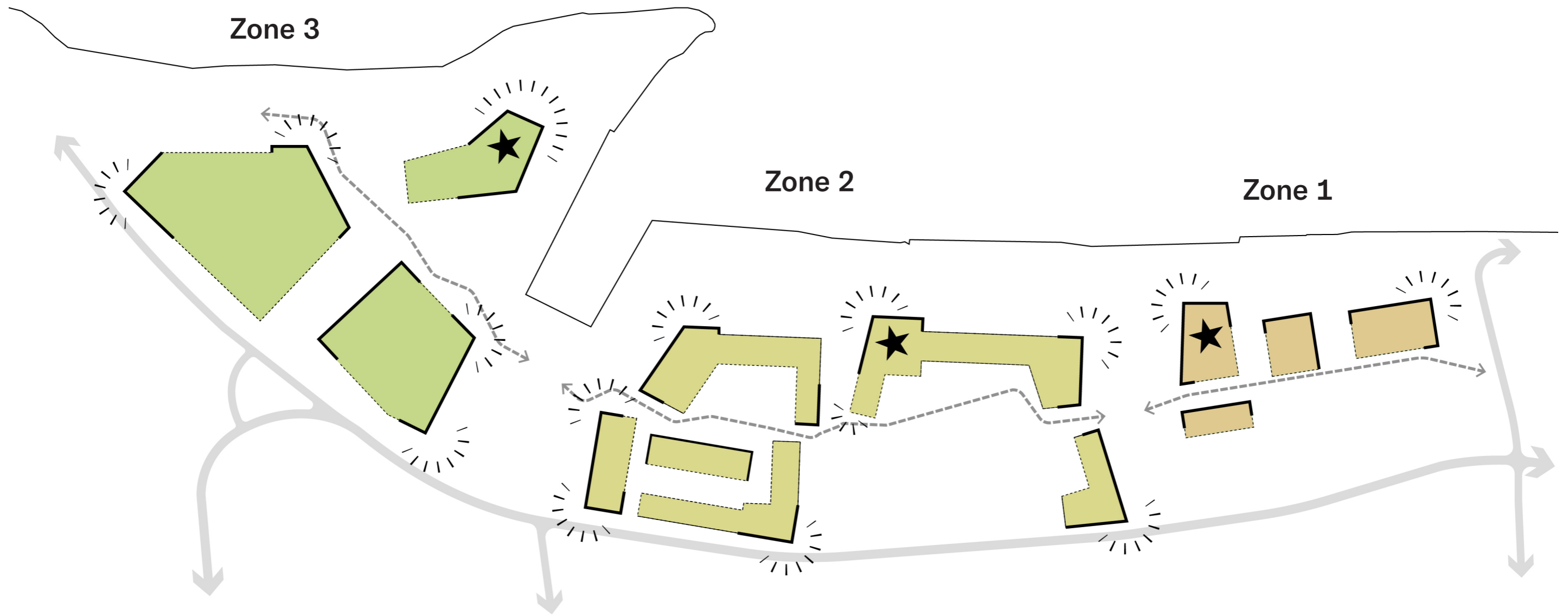

Globale 3D Massa Opbouw Overzicht



Vogelvluchtimpresie van het plangebied, het betreft een schetsimpresie geen precieze weergave van het stedenbouwkundig plan

RELATIE MET DE OMGEVING

AANZICHT VANUIT DE STAD VANAF DE STER



AANZICHT VANUIT DE STAD VANAF HET AKCROS PARK



AANZICHT VANUIT DE STAD VANAF HET STEEL (ECI)



AANZICHT VANAF HET WATER VANAF DE LANDTONG

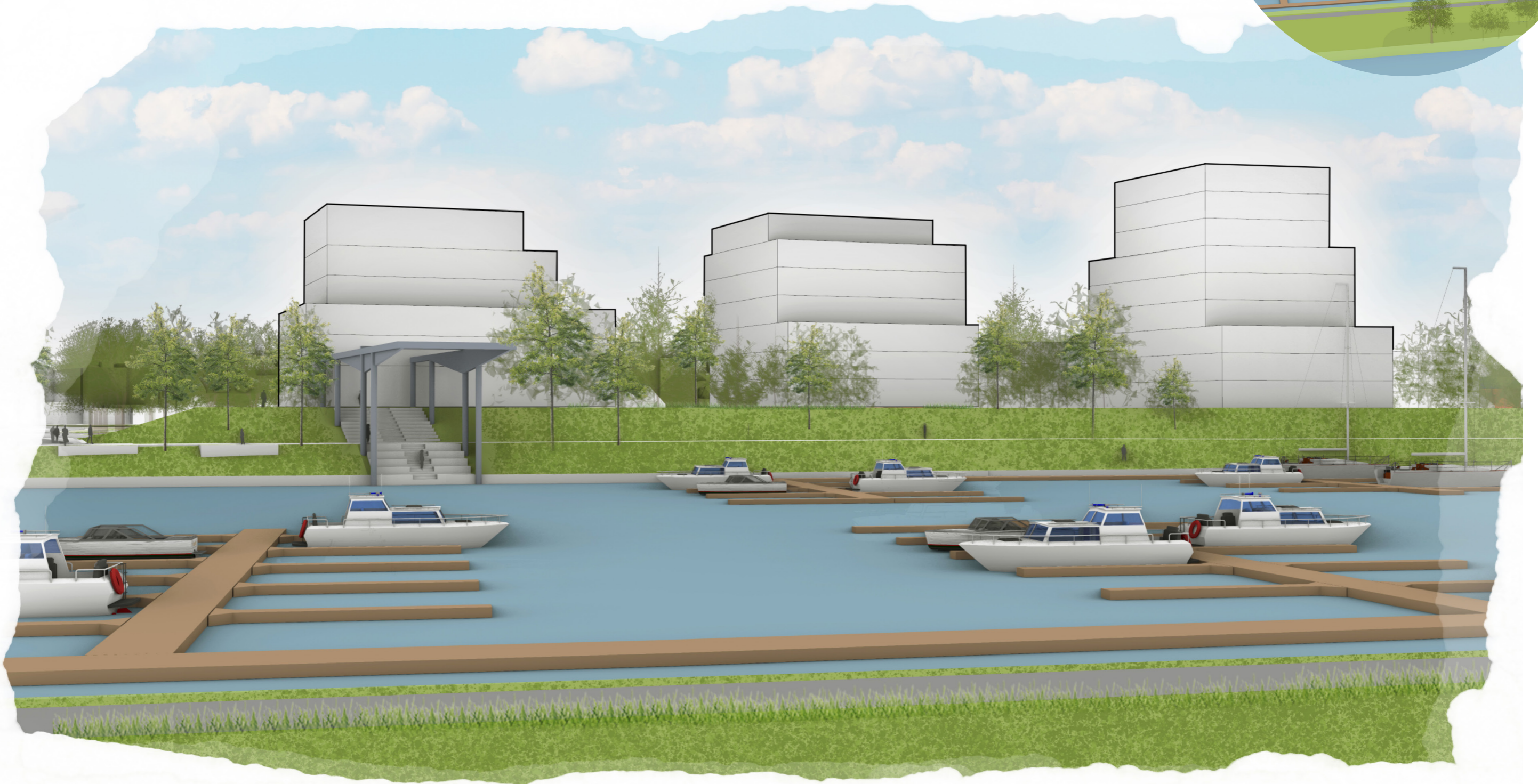
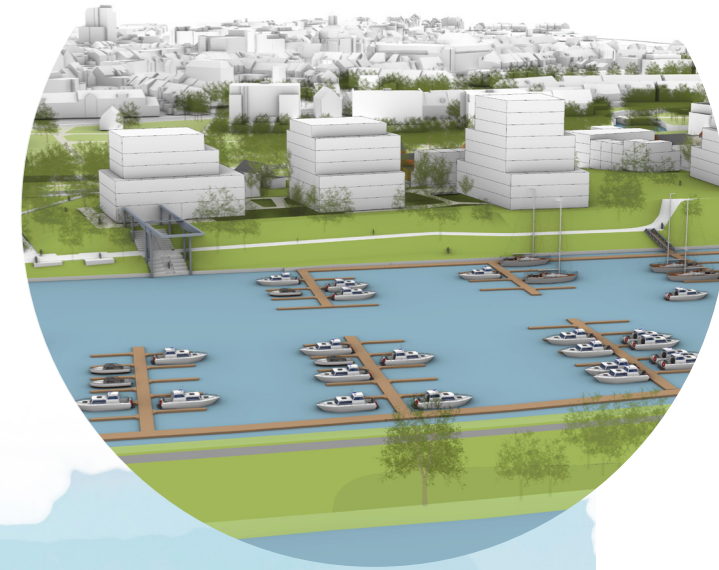

AANZICHT VANUIT DE STAD VANAF DE BURGEMEESTER HÖPPENERLAAN

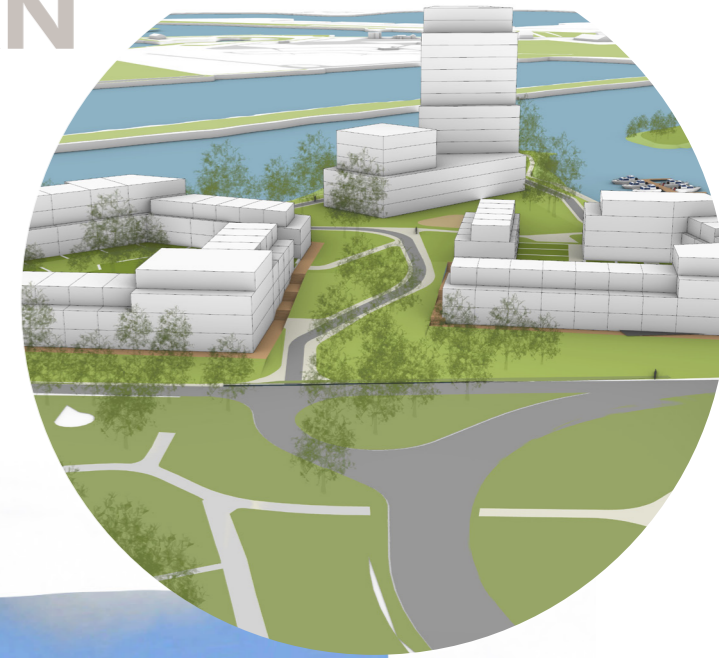

SKYLINE ROERMOND MET ACCENTEN

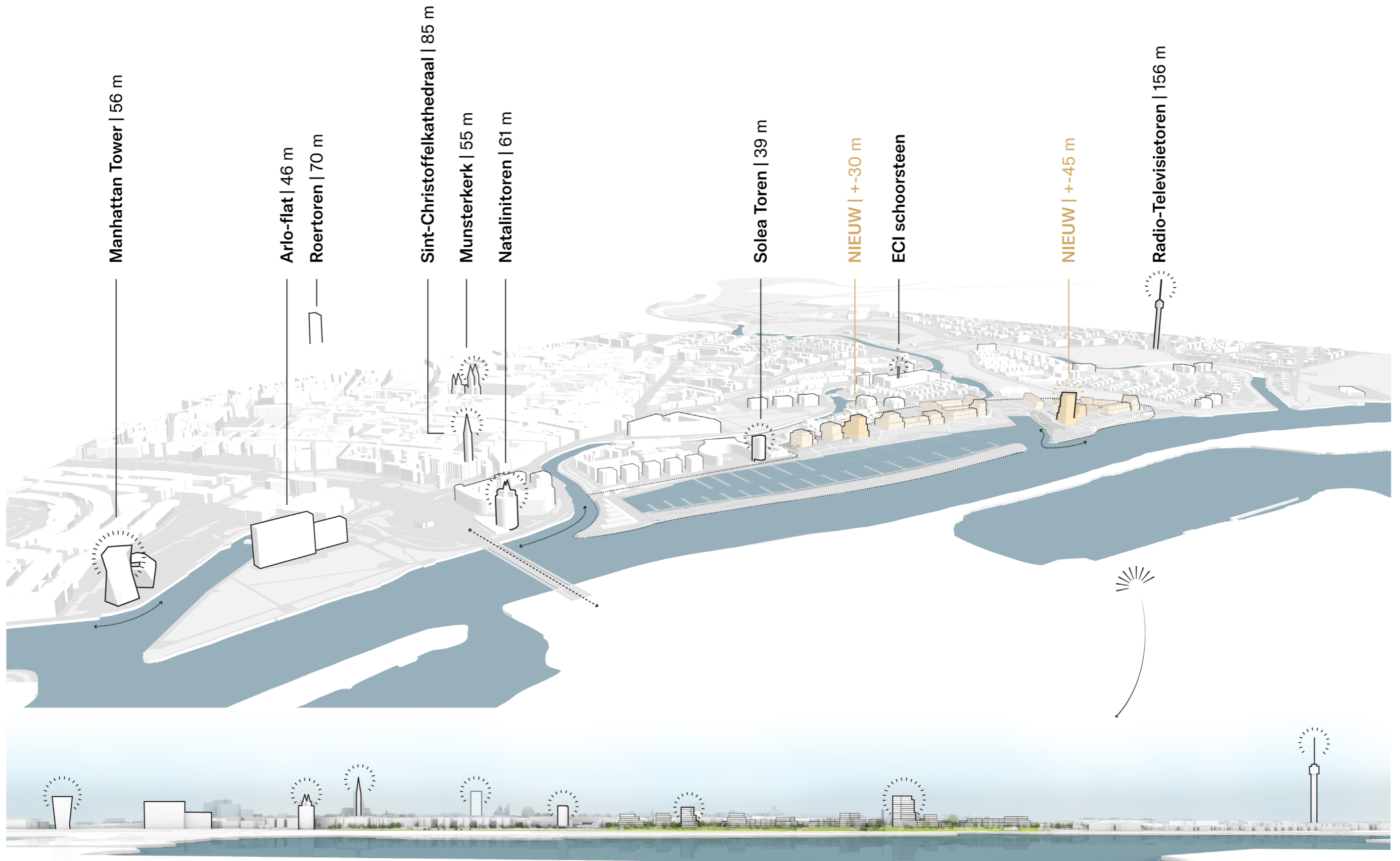

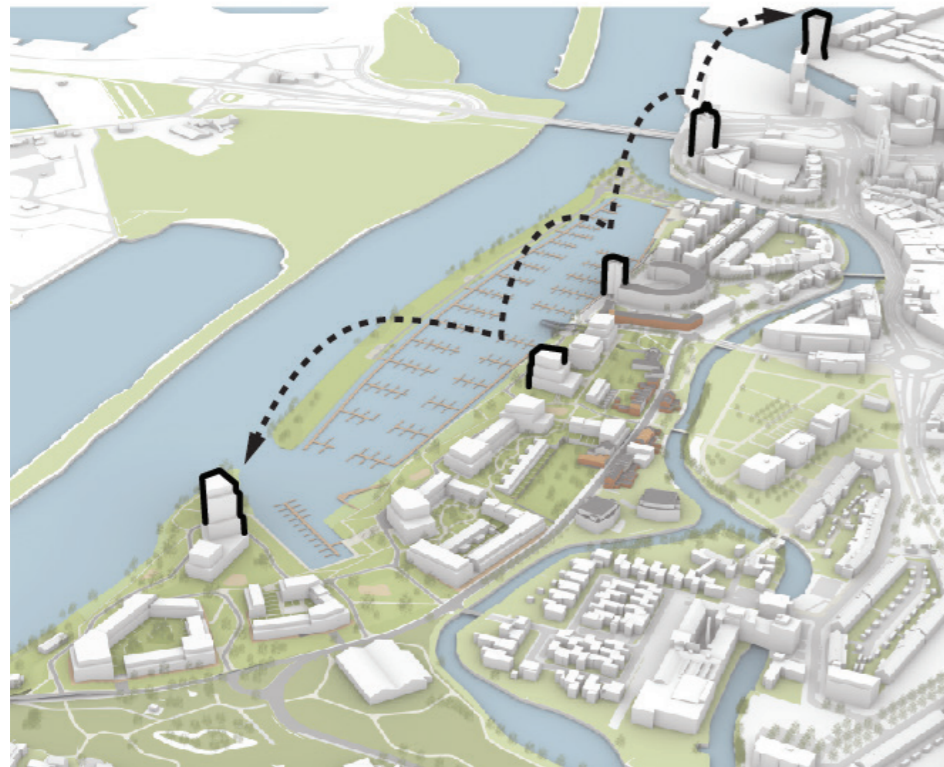

Accent op schaal van de stad Roermond
Hoogteaccent op het maaseiland

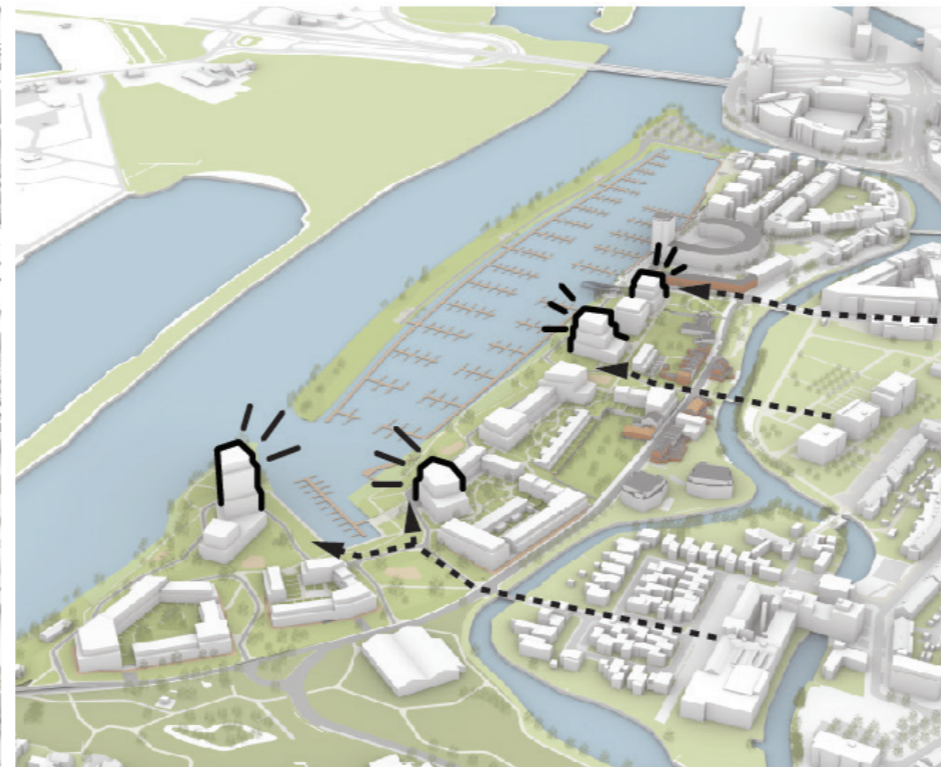

Accenten langs de dwarsverbindingen
Relatie met de directe context

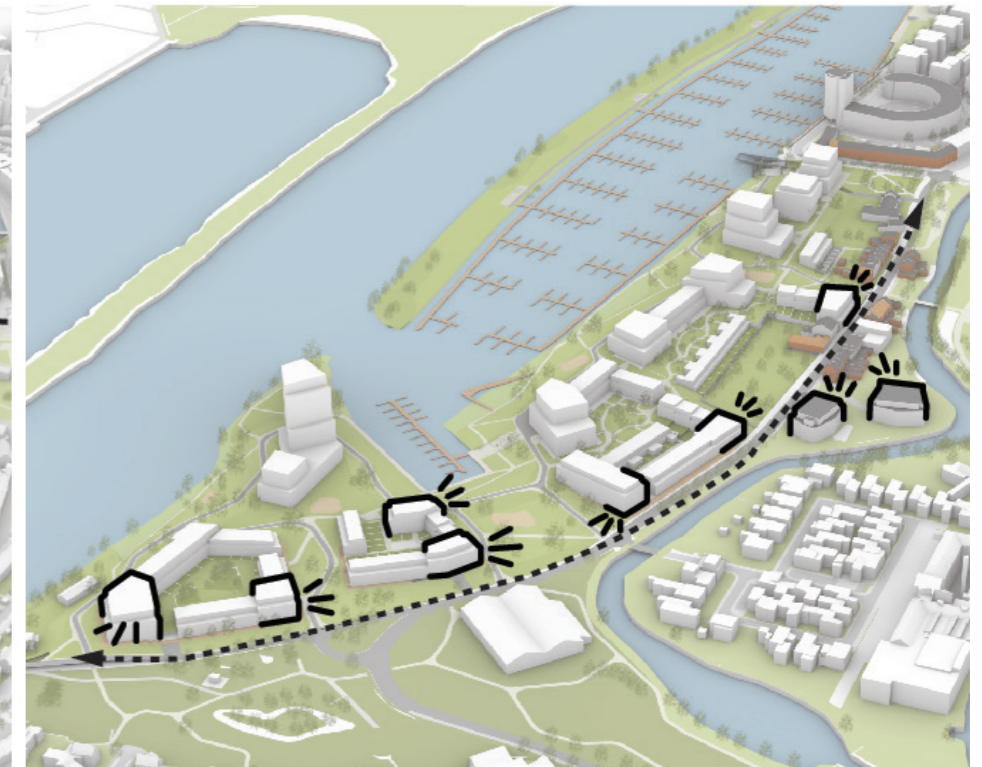

Accenten op de hoeken in relatie met de
Voorstad St Jacob



BEELDKWALITEIT

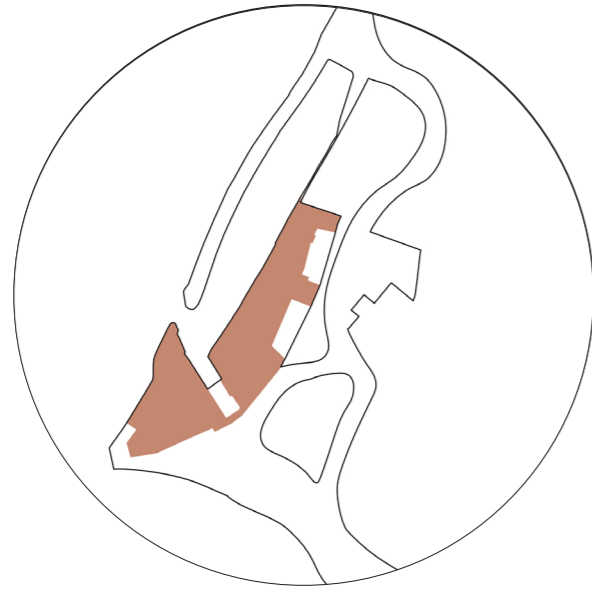

1. Samenhang

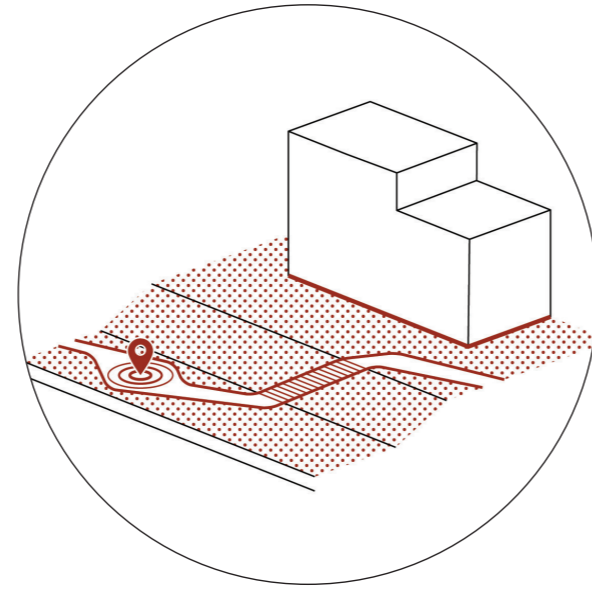

2. Parklandschap

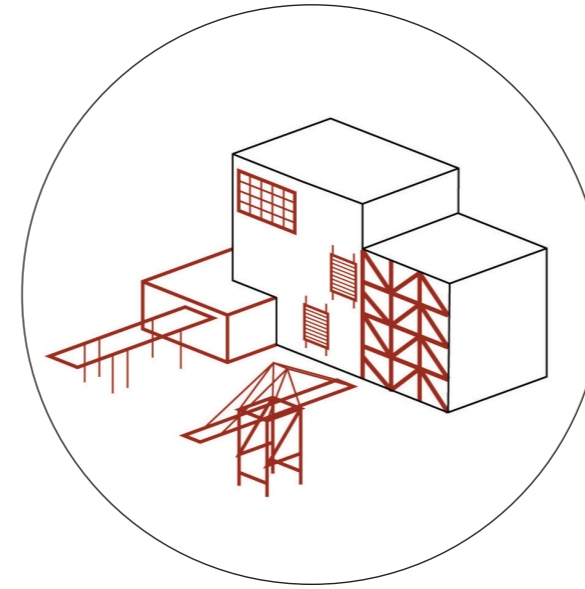

3. Industrieel / nautisch karakter

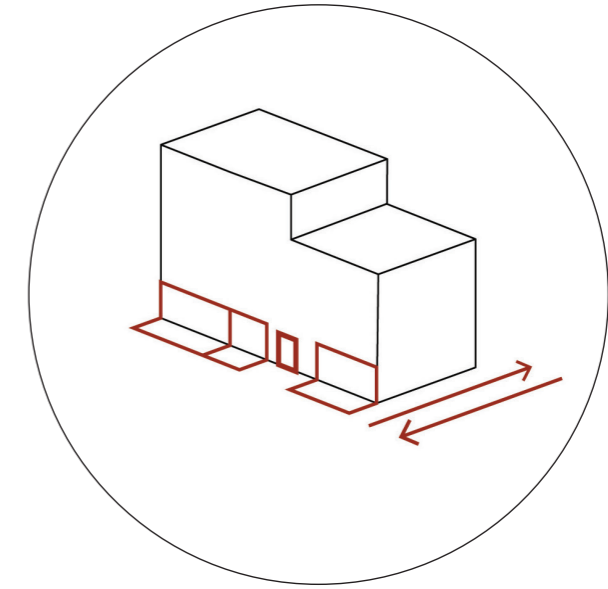

4. Adressen

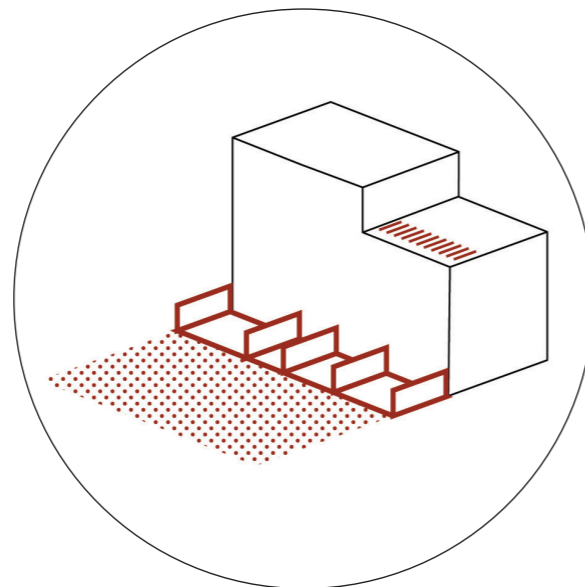

5. Buitenruimte

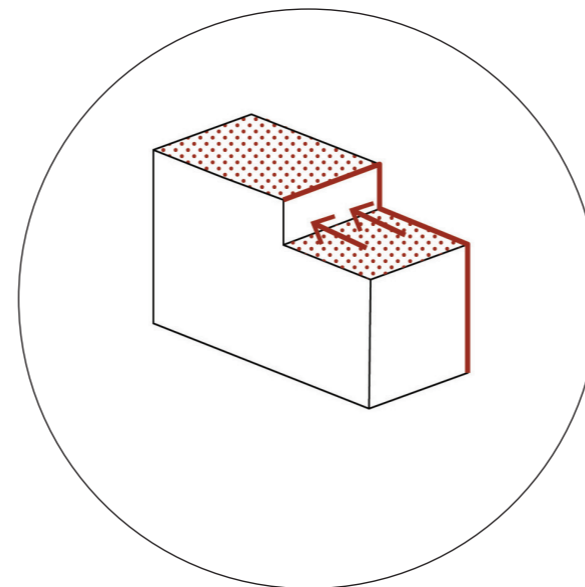

6. Geleding en compositie

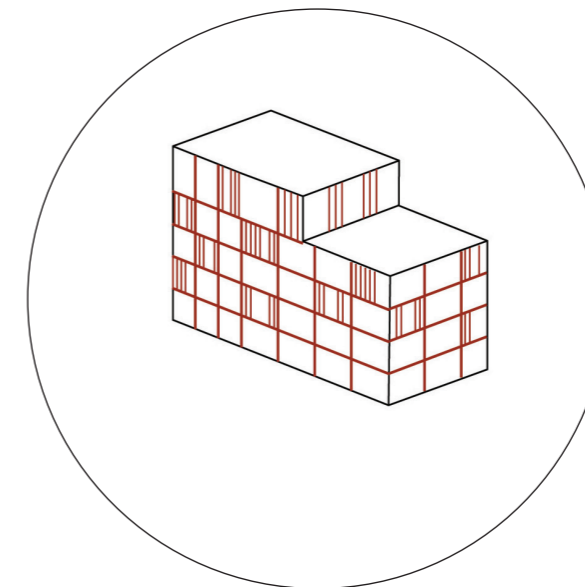

7. Materialisatie principes

SAMENHANG IN PLAN

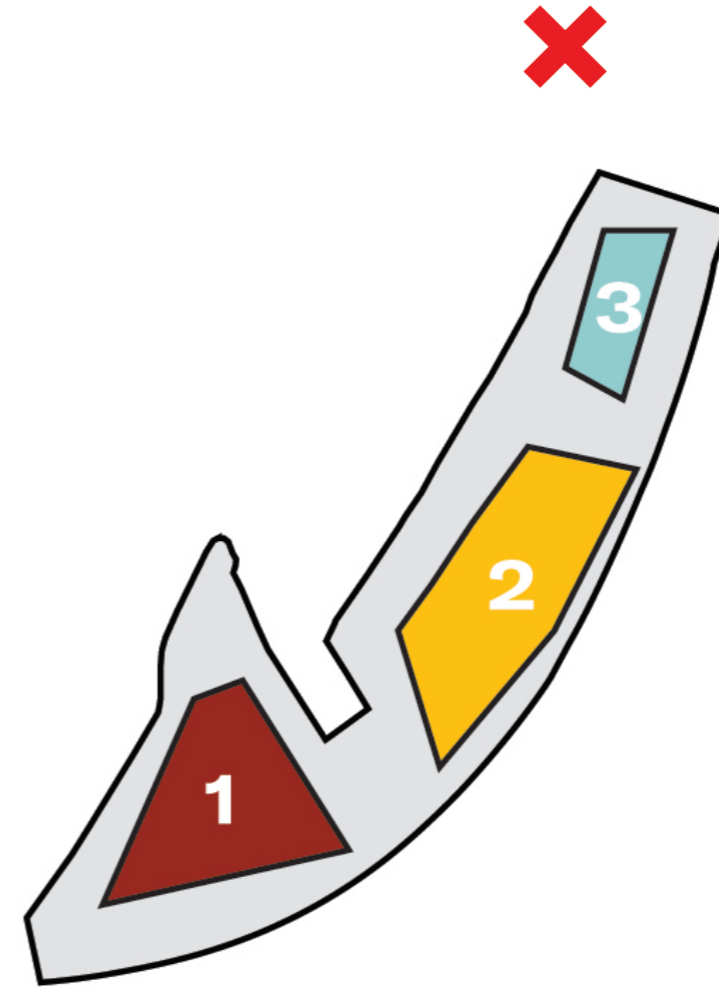
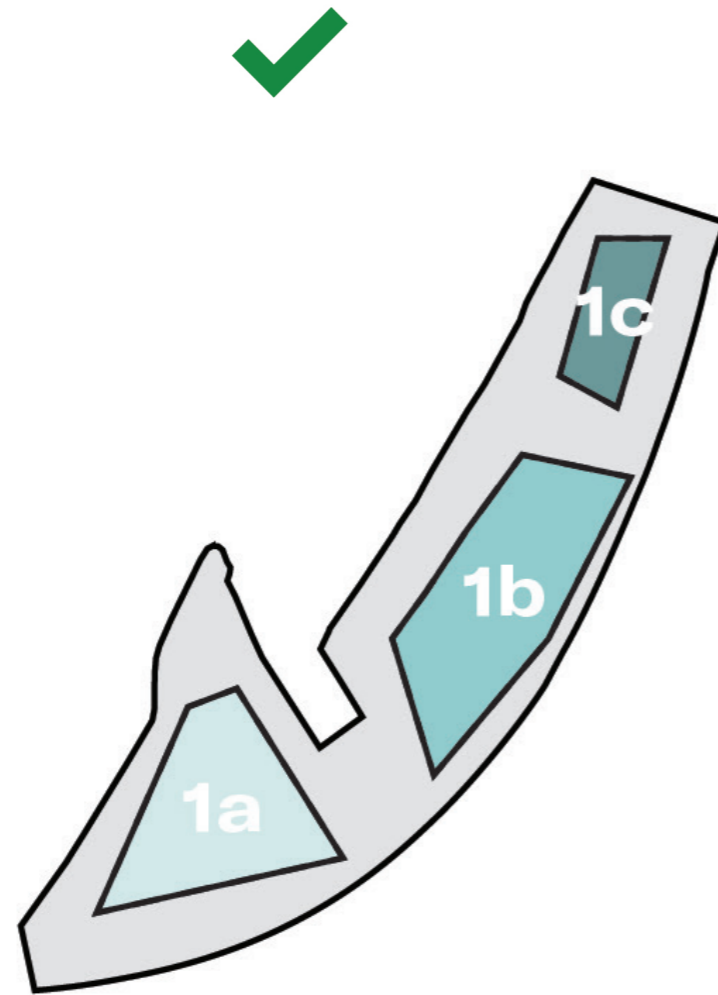

Objecten hergebruiken

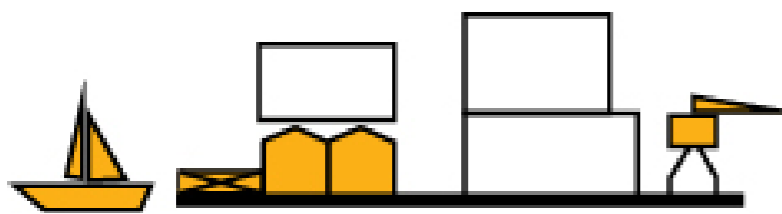

Industriële en nautische materialen

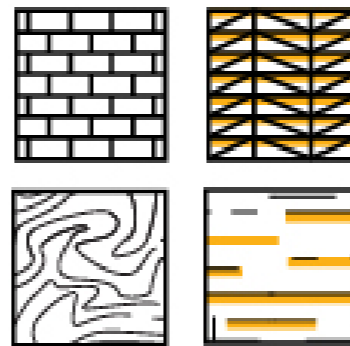

Vistas

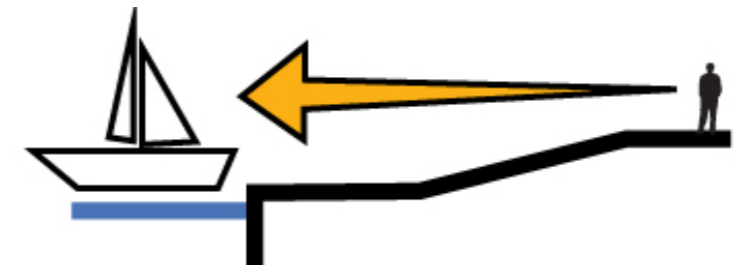

Blokken staan in het groen

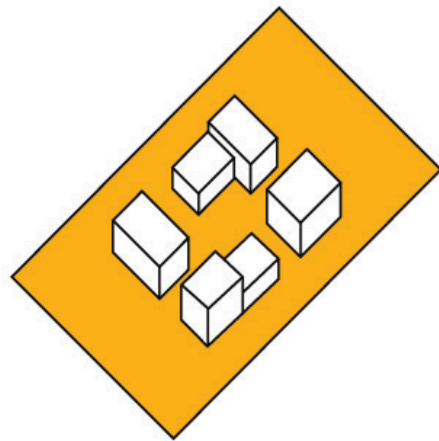

Autovrije openbare & collectieve ruimtes

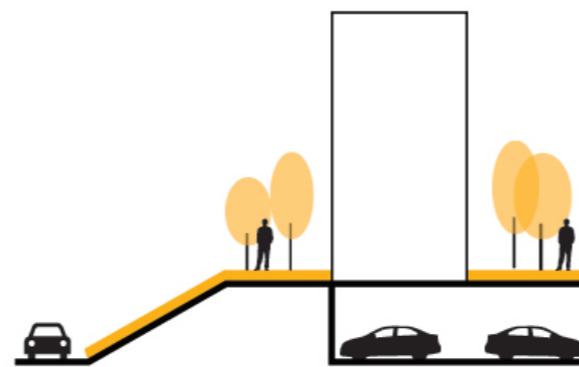

Diverse beplanting

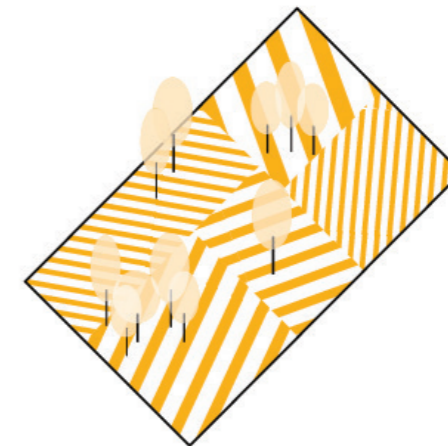

Groene landtong, zo min mogelijk verharding

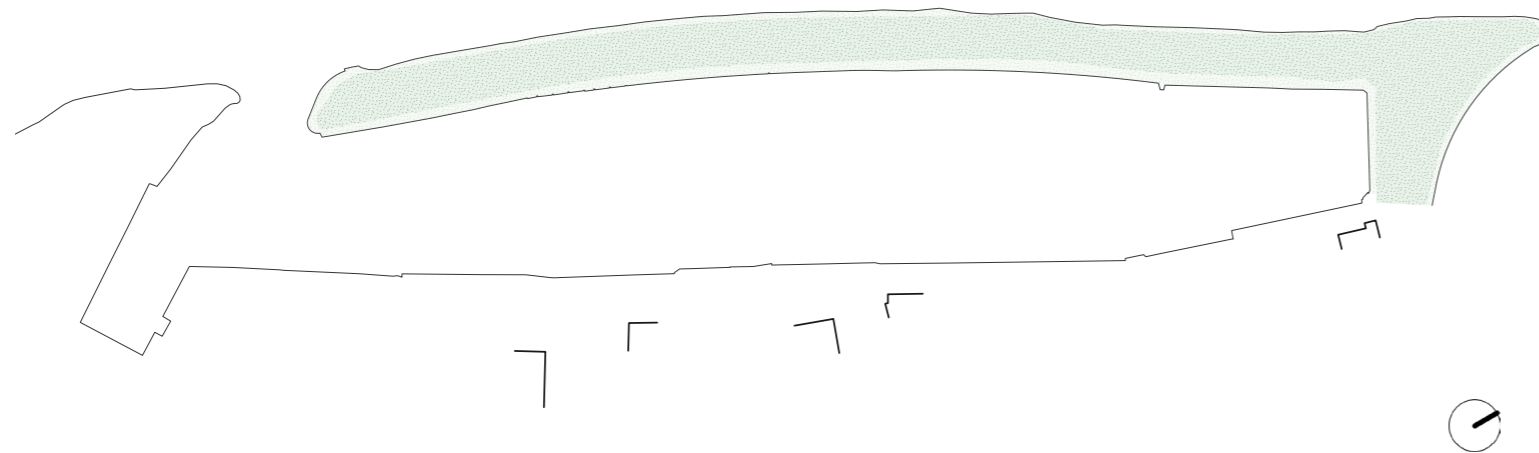

Biotopen en zichtlijnen

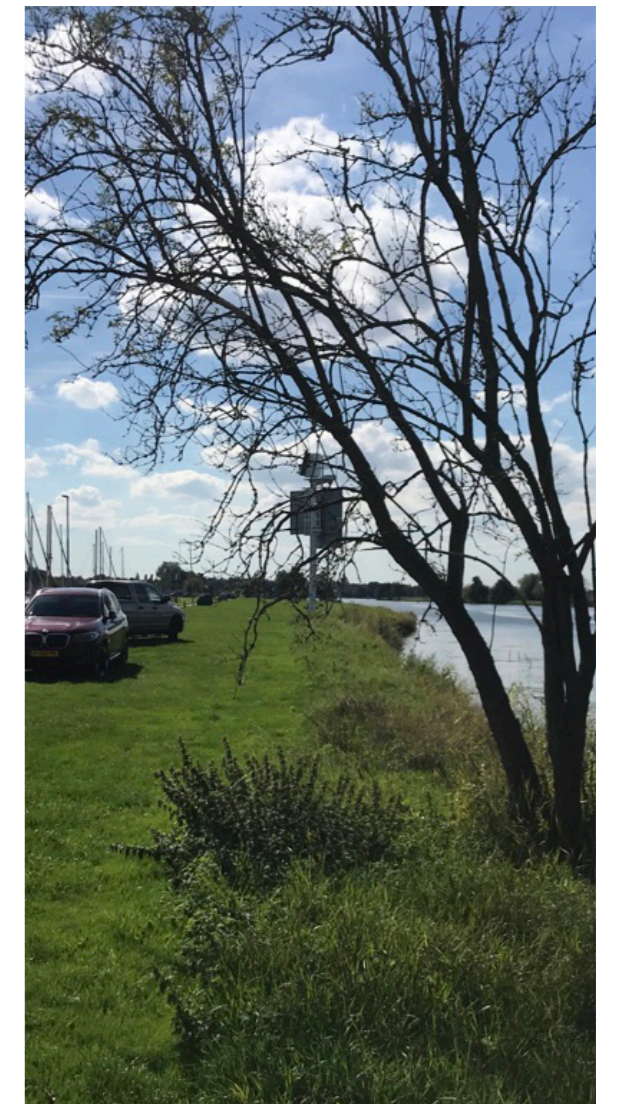
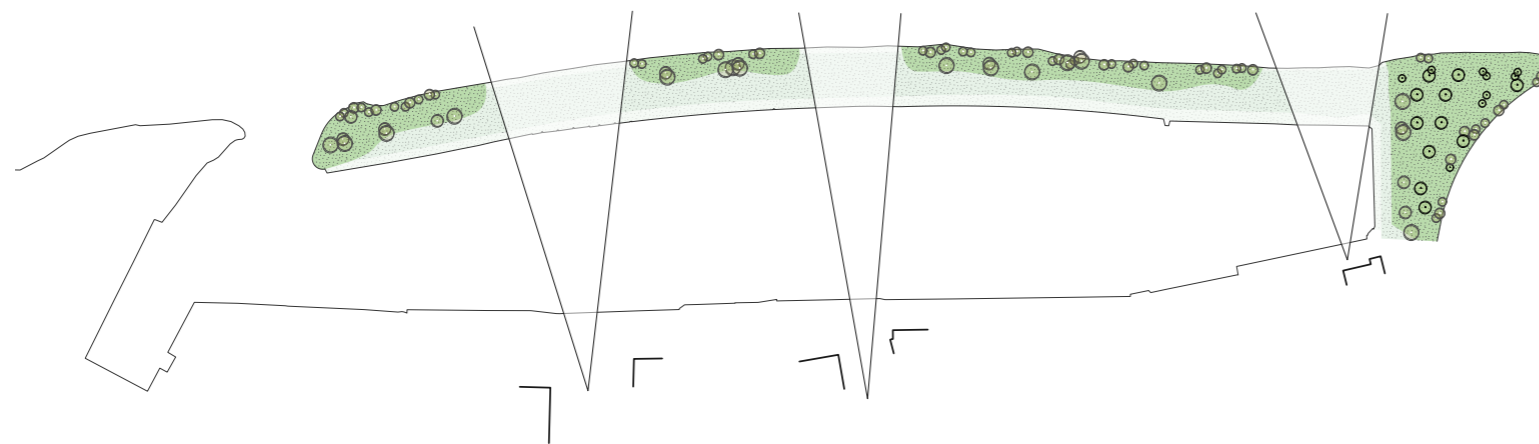

Oeverbeplanting en struwelen

Laad en los zones

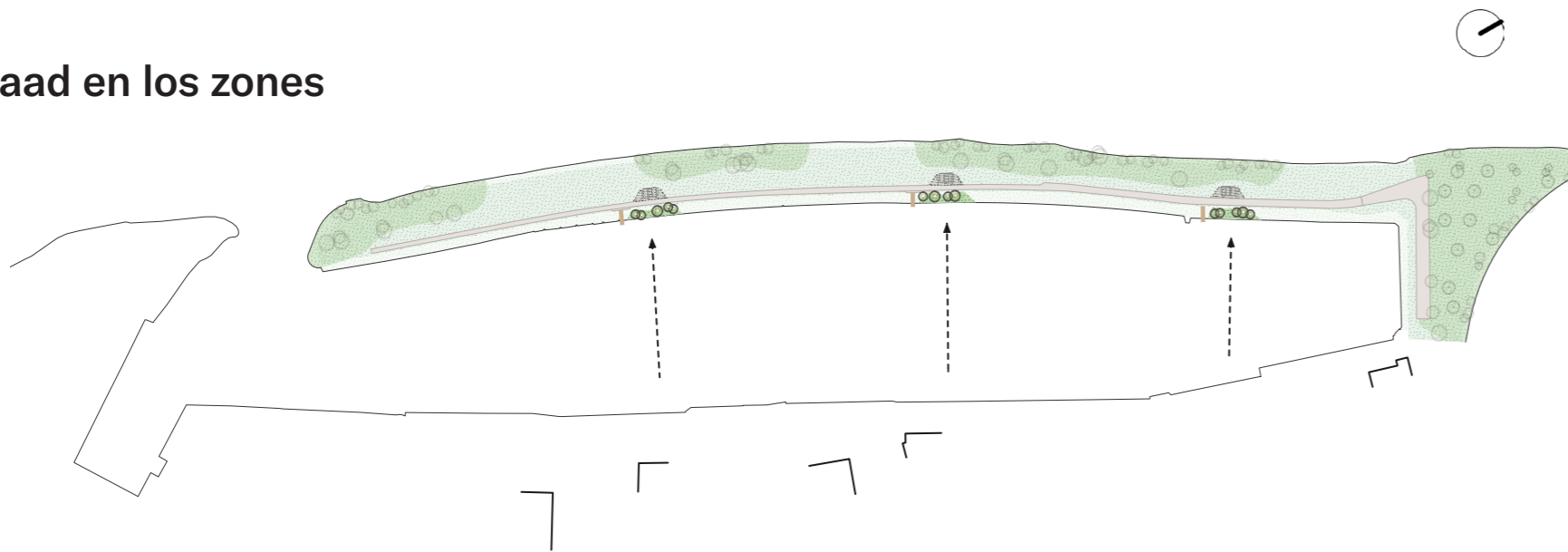

Parkeren in clusters

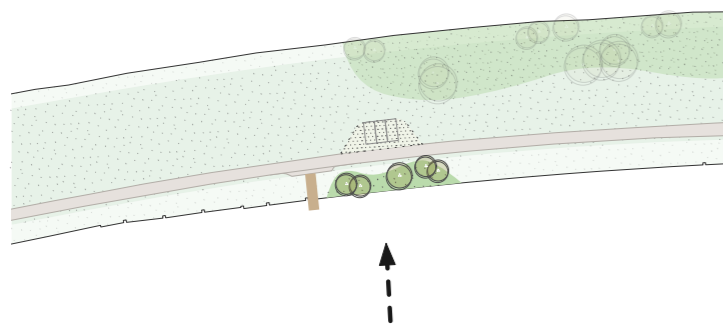

Parkeren achter struweel

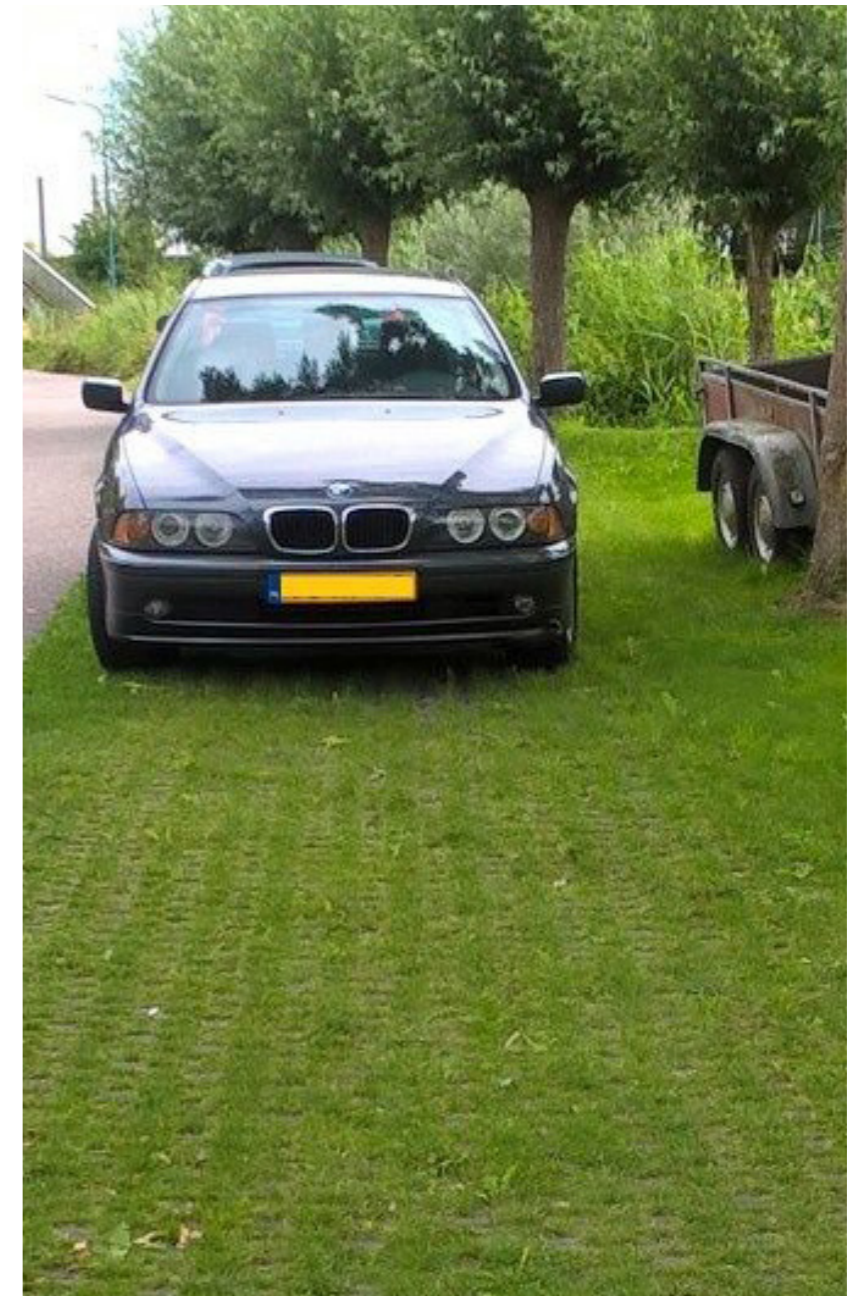
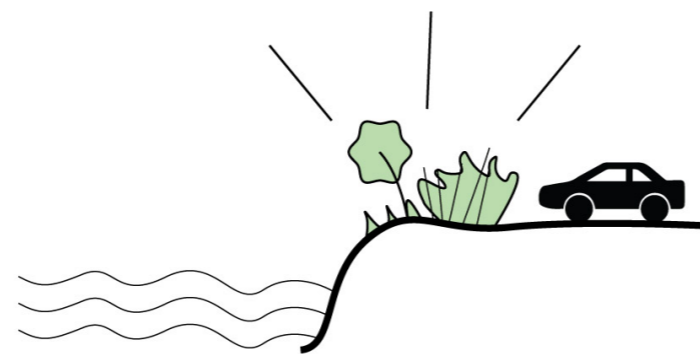

Grasbetonverharding

Parkeren landtong

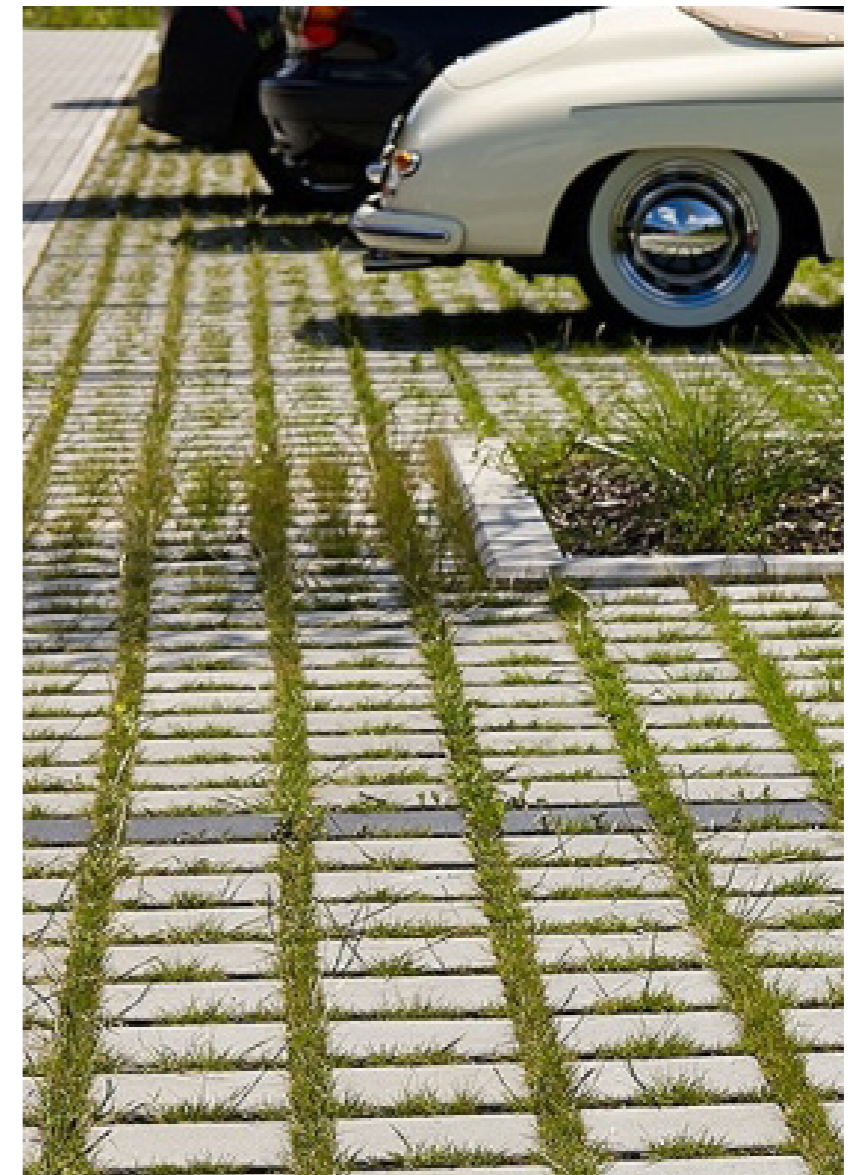

Grasbetonverharding

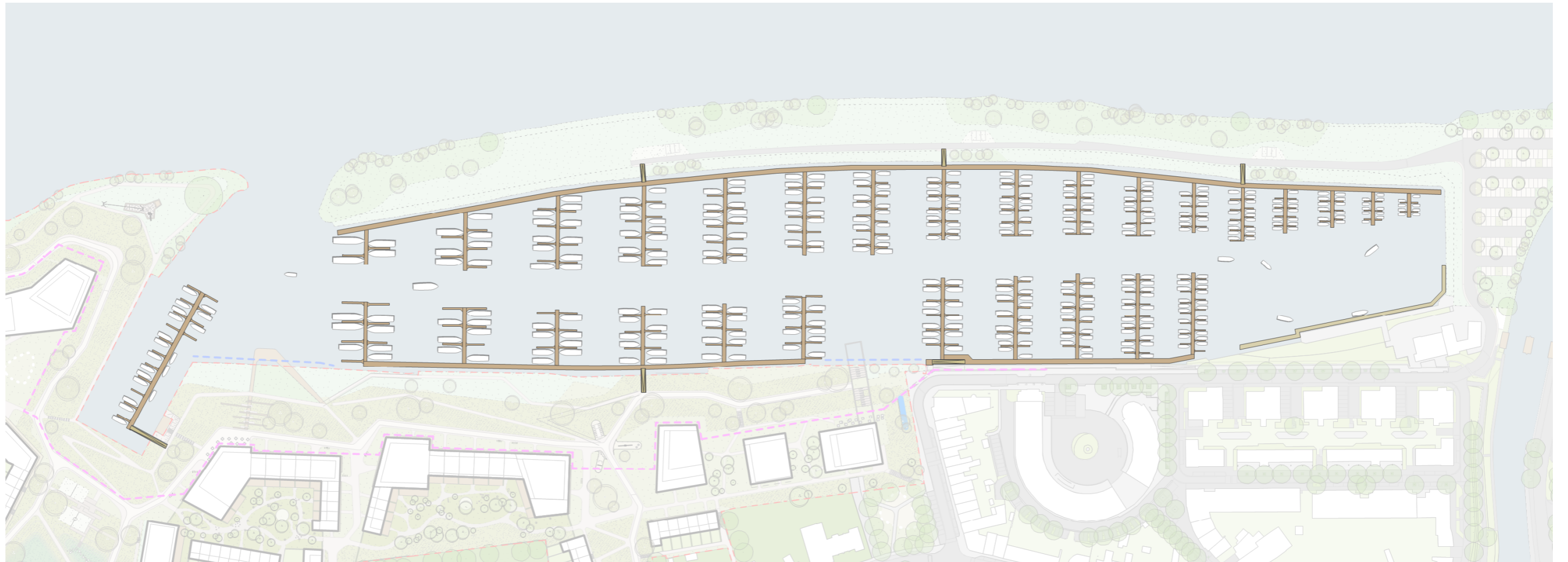

Globale 3D Massa Opbouw Overzicht



Vogelvlichtimpressie van het plangebied, het betreft een schetsimpressie geen precieze weergave van het stedenbouwkundig plan